

SENSOR LIQUID SOAP DISPENSER WP174E-2 FOR MOUNTING BEHIND FIXED MIRROR



86 x 287(248) x 148 mm

500 ml or 950 ml soap bottle or 850 ml plug-in tank

- Sensor liquid soap dispenser in robust, germ-reducing and easy-care stainless steel (AISI 316L).
- For mounting behind fixed mirror on site.
- With EWAR® eModule touch-free operated and non-drip soap pump.
- Designed for standard 500 ml or 950 ml disposable bottles of liquid soap or hand lotion. Accessible for refilling through spring stop pin and by removing from below.
- Also refillable with large container using the plug-in tank as an option.
- eModule battery-powered with two 1.5 V Baby/LR14 batteries. Power supply available as an option.
- Wear parts can be replaced as modules.
- Mounting: With two screws through key holes and one optional anti-theft hole in the back wall. Depth of substructure installation: min. 185 mm Height above vanity unit: min. 250(280) mm
- Delivery includes fixing material, batteries, self-adhesive information label „Soap“ and first fill with soap.
- Weight, including single package: 1.9 kg



Suggested text for specifications:

Sensor liquid soap dispenser in stainless steel (AISI 316L) for mounting behind fixed mirror. With touch-free operated and non-drip soap pump. Designed for standard 500 ml or 950 ml disposable bottles of liquid soap or hand lotion. Accessible for refilling through spring stop pin and by removing from below. Delivery includes fixing material, batteries, self-adhesive information label „Soap“ and first fill with soap.

Dimensions: 86 x 287(248) x 148 mm

Article No. WP174e-2

Options	ID No.
Plug-in tank 850 ml	937 201
Power supply for eModule	923 060

Available surface	ID No.
satin finished	727 039

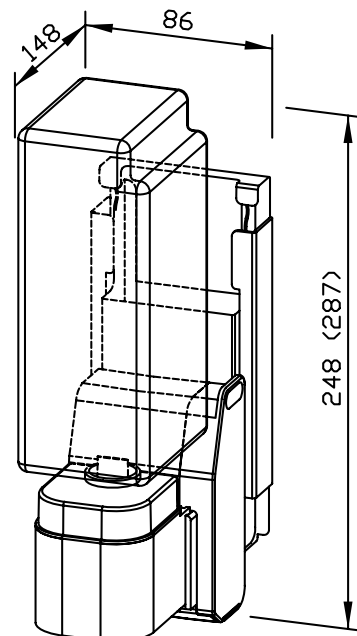

Ernst Wagner GmbH & Co. KG

Ernst-Abbe-Straße 21 · D-72770 Reutlingen · Tel.: +49712151539-0 · Fax: -20
info@wagner-ewar.de · www.wagner-ewar.de

WAGNER
EWAR