

COMBINATION PAPER ROLL/WASTE WP5456



448 x 1348 x 220 mm

Sensor paper roll dispenser battery-powered, 48 l waste bin

- Combination consisting of a sensor paper roll dispenser (battery-powered) and a waste bin in robust, germ-reducing and easy-care stainless steel (AISI 304).
- All-stainless steel housing; all corners fully welded, visible surfaces satin finished and brushed. Further available surfaces: see below.
- Paper roll dispenser with touch-free operated, capacitive sensor technology, sensor distance approx. 3.5 cm. Paper length and idle time adjustable. Battery-powered with four standard 1.5 V Mono/LR20/12 A batteries.
- Designed for one paper roll and one reserve roll with dimensions: Width 215 mm, outer diameter max. 180 mm, inner diameter 50 mm.
- Inspection slot to indicate fill level, residual roll function allows a reserve roll to be inserted before residual roll is completely used up.
- Waste bin equipped with removable mesh basket. Capacity approx. 48 l.
- Accessible through lockable doors.
- Keyed alike cylinder locks in corrosion-resistant zinc die-casting.
- Wear parts can be replaced as modules.
- Mounting: With six screws through key holes and one optional anti-theft hole in the back wall.
- Delivery includes fixing material and first fill with one paper roll.
- Weight, including single package: 26.1 kg



Suggested text for specifications:

Combination consisting of a sensor paper roll dispenser (battery-powered) and a waste bin in stainless steel (AISI 304) for surface mounting. All-stainless steel housing; all corners fully welded, visible surfaces satin finished and brushed. Paper roll dispenser with touch-free operated, capacitive sensor technology. Paper length and idle time adjustable. Battery-powered with four standard 1.5 V Mono/LR20/12 A batteries. Designed for one paper roll with dimensions: Width 215 mm, outer diameter max. 180 mm, inner diameter 50 mm. Inspection slot to indicate fill level. Waste bin equipped with removable mesh basket. Capacity approx. 48 l. Accessible through lockable doors. Keyed alike cylinder locks in corrosion-resistant zinc die-casting. Delivery includes fixing material and first fill with one paper roll.

Dimensions: 448 x 1348 x 220 mm

Article No. WP5456

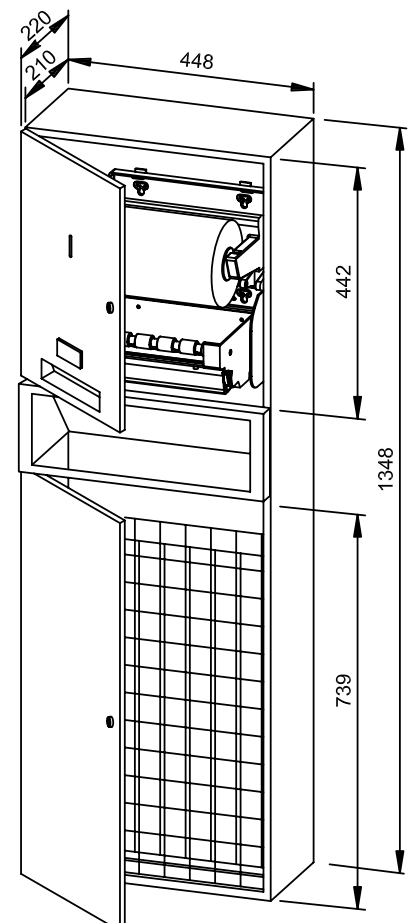

Available surfaces

ID No.

satin finished (standard)

722 977

highly polished

731 977

(coloured) plastic powder-coating

728 977

Ernst Wagner GmbH & Co. KG

Ernst-Abbe-Straße 21 · D-72770 Reutlingen · Tel.: +49712151539-0 · Fax: -20
info@wagner-ewar.de · www.wagner-ewar.de

WAGNER
EWAR